



YOUR OUTDOOR LIVING

price list
2017

OUTDOOR
GARDEN
CONTRACT

IVA esclusa / Vat excluded

Prezzi validi dal 01 Ottobre 2016 salvo art. 1.3 delle condizioni generali
Prices valid from 1st October 2016 except art. 1.3 of the general terms of sale

listino prezzi / price list
2017

**OUTDOOR
GARDEN
CONTRACT**

INDICE / INDEX

SEDUTE IN POLIPROPILENE / polypropylene seats	9
SEDUTE IN POLIPROPILENE E ALLUMINIO / polypropylene and aluminium seats	19
LETTINI / sunloungers	25
TAVOLI IN POLIPROPILENE / polypropylene tables	31
TAVOLI IN POLIPROPILENE E ALLUMINIO / polypropylene and aluminium tables	35
TAVOLI LOTO / loto tables	41
TAVOLI POLO / polo tables	45
BASI IN ALLUMINIO / aluminium bases	51
PIANI / tops	57
CUSCINI E ACCESSORI / cushions and accessories	67
MATERIALI / materials	71
CONDIZIONI GENERALI DI VENDITA / general terms of sale	79

LEGENDA / LEGEND

	impilabile / <i>stackable</i>
	impilabile orizzontalmente / <i>stackable horizontally</i>
	pieghevole / <i>folding</i>
	reclinabile / <i>reclining</i>
	tessuto sintetico / <i>synthetic fabric</i>
	tessuto acrilico / <i>acrylic fabric</i>
	allungabile / <i>extensible</i>
	sfoderabile / <i>removeable</i>
	prodotto da montare / <i>assembly required</i>
	cuscinio disponibile su ordinazione / <i>cushion available to order</i>
	cuscini arredo e seduta inclusi / <i>cushions Arredo and Seduta included</i>
	dotato di rotelline / <i>with small wheels</i>
	dotato di piedini antiscivolo / <i>with non-slip feet</i>
	dotato di piedini regolabili / <i>with adjustable feet</i>
	polipropilene / <i>polypropylene</i>
	polipropilene fiber-glass / <i>polypropylene fiberglass</i>
	alluminio anodizzato / <i>anodized aluminium</i>
	alluminio verniciato / <i>coated aluminium</i>
	vetro temperato serigrafato / <i>tempered screen-printed glass</i>
	laminato HPL sp. 12 mm / <i>laminate HPL 12 mm. thickness</i>
	durelTOP / <i>durelTOP</i>
	werzalit - topalit / <i>werzalit - topalit</i>
	ignifugo / <i>fireproof</i>
	alluminio trattamento speciale/ <i>aluminium special treatment</i>
	tessuto impermeabile/ <i>waterproof fabric</i>
	tessuto idrorepellente/ <i>water-repellent fabric</i>
	peso del prodotto in chilogrammi / <i>weight of the model in kg</i>
	imballo con film - n. pezzi e volume in m ³ / <i>shrink-wrapped packing - number of pcs and volume in cbm</i>
	imballo cartonato - n. pezzi e volume in m ³ / <i>carton packing - number of pcs and volume in cbm</i>
	n. pezzi su pallet / <i>number of pcs on pallet</i>
	prodotto adatto all'utilizzo in esterno / <i>product suitable for outdoor use</i>
	prodotto certificato Catas / <i>product certified by Catas</i>

**SEDUTE IN
POLIPROPILENE**

polypropylene seats

modello
model

info
info

colore
colour

ref.
ref.

€
€

net relax **new**

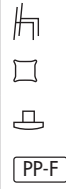
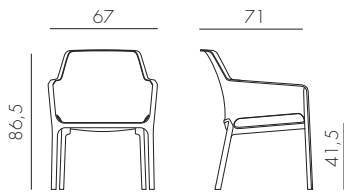

4,7
 20
1,810 m³
 20 pz

CADAS

	BIANCO	40327.00.000
	ANTRACITE	40327.02.000
	SALICE	40327.04.000
	TORTORA	40327.10.000
	SENAPE	40327.56.000
	CORALLO	40327.75.000

€ 99,00

net

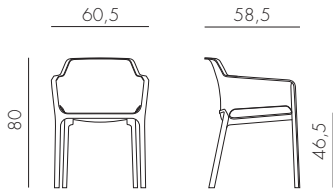

4,1
 22
1,455 m³
 22 pz

CADAS

	BIANCO	40326.00.000
	ANTRACITE	40326.02.000
	SALICE	40326.04.000
	TORTORA	40326.10.000
	SENAPE	40326.56.000
	CORALLO	40326.75.000

€ 84,00

bit **new**

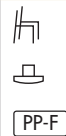
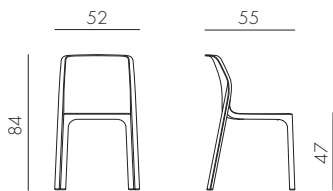

3,5
 24
1,440 m³
 24 pz

CADAS

	BIANCO	40328.00.000
	ANTRACITE	40328.02.000
	SALICE	40328.04.000
	TORTORA	40328.10.000
	SENAPE	40328.56.000
	CORALLO	40328.75.000

€ 72,00

modello
model

info
info

colore
colour

ref.
ref.

€
€

bora

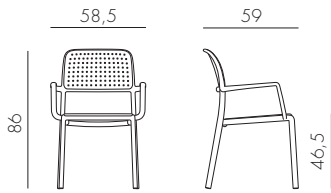

PP-F



4,4



24
1,522 m³



24 pz



CADAS



BIANCO

40242.00.000



ANTRACITE

40242.02.000



CAFFÈ

40242.05.000



ROSSO

40242.07.000



TORTORA

40242.10.000



AVANA

40242.33.000



CELESTE

40242.39.000

€ 63,50

bora bistrot

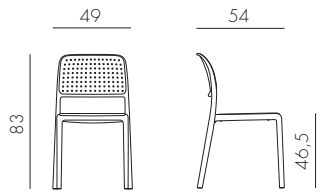

PP-F



3,7



24
1,438 m³



24 pz



CADAS



BIANCO

40243.00.000



ANTRACITE

40243.02.000



CAFFÈ

40243.05.000



ROSSO

40243.07.000



TORTORA

40243.10.000



AVANA

40243.33.000



CELESTE

40243.39.000

€ 56,50

riva

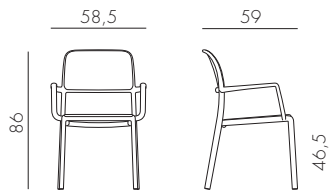

PP-F



4,6



24
1,522 m³



24 pz



CADAS



BIANCO

40246.00.000



ANTRACITE

40246.02.000



CAFFÈ

40246.05.000



ROSSO

40246.07.000



TORTORA

40246.10.000



AVANA

40246.33.000



CELESTE

40246.39.000

€ 68,00

riva bistrot

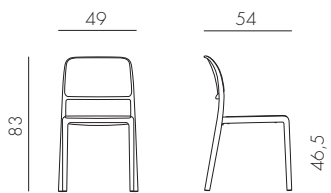

PP-F



4



24
1,438 m³



24 pz



CADAS



BIANCO

40247.00.000



ANTRACITE

40247.02.000



CAFFÈ

40247.05.000



ROSSO

40247.07.000



TORTORA

40247.10.000



AVANA

40247.33.000



CELESTE

40247.39.000

€ 60,50

modello
model

info
info

colore
colour

ref.
ref.

€

costa

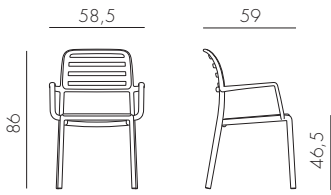

Kg 4,5
F 24
1,522 m³
24 pz
CADIS

	BIANCO	40244.00.000
	ANTRACITE	40244.02.000
	CAFFÈ	40244.05.000
	ROSSO	40244.07.000
	TORTORA	40244.10.000
	CELESTE	40244.39.000

€ 63,50

costa bistrot

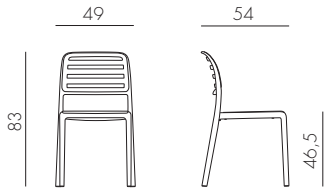

Kg 3,9
F 24
1,438 m³
24 pz
CADIS

	BIANCO	40245.00.000
	ANTRACITE	40245.02.000
	CAFFÈ	40245.05.000
	ROSSO	40245.07.000
	TORTORA	40245.10.000
	CELESTE	40245.39.000

€ 56,50

acquamarina

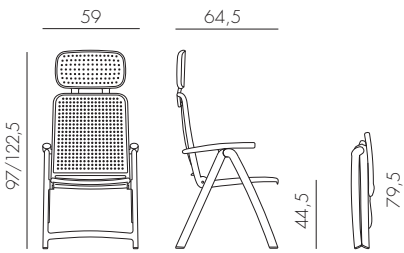

Kg 8
C 1
0,086 m³
26 pz
CADIS

	BIANCO	40314.00.000
	ANTRACITE	40314.02.000
	CAFFÈ	40314.05.000
	TORTORA	40314.10.000
	CELESTE	40314.39.000

€ 110,50

darsena

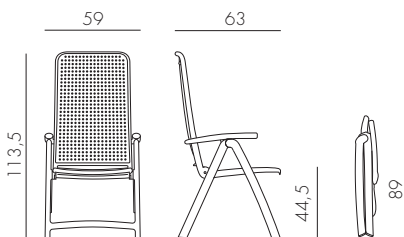

Kg 7,7
C 1
0,085 m³
28 pz
CADIS

	BIANCO	40316.00.000
	ANTRACITE	40316.02.000
	CAFFÈ	40316.05.000
	TORTORA	40316.10.000
	CELESTE	40316.39.000

€ 97,00

modello
model

info
info

colore
colour

ref.
ref.

€
€

lido

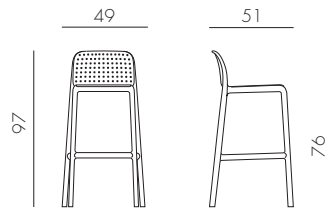

4,3
 4
0,347 m³
 32 pz

CADIS

	BIANCO	40344.00.000
	ANTRACITE	40344.02.000
	CAFFÈ	40344.05.000
	ROSSO	40344.07.000
	TORTORA	40344.10.000
	AVANA	40344.33.000
	CELESTE	40344.39.000

€74,00

lido mini new

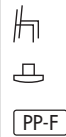
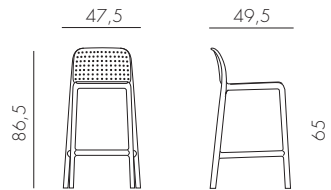

3,9
 4
0,322 m³
 32 pz

CADIS

	BIANCO	40345.00.000
	ANTRACITE	40345.02.000
	CAFFÈ	40345.05.000
	ROSSO	40345.07.000
	TORTORA	40345.10.000
	AVANA	40345.33.000
	CELESTE	40345.39.000

€74,00

faro

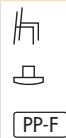
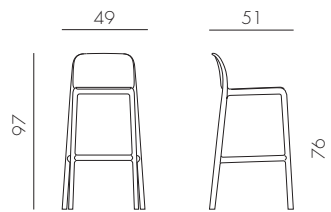

4,5
 4
0,347 m³
 32 pz

CADIS

	BIANCO	40346.00.000
	ANTRACITE	40346.02.000
	CAFFÈ	40346.05.000
	ROSSO	40346.07.000
	TORTORA	40346.10.000
	AVANA	40346.33.000
	CELESTE	40346.39.000

€74,00

faro mini new

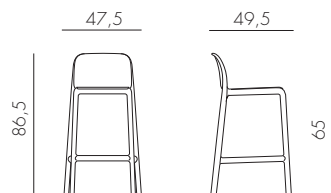

4
 4
0,322 m³
 32 pz

CADIS

	BIANCO	40347.00.000
	ANTRACITE	40347.02.000
	CAFFÈ	40347.05.000
	ROSSO	40347.07.000
	TORTORA	40347.10.000
	AVANA	40347.33.000
	CELESTE	40347.39.000

€74,00

modello
model

info
info

colore
colour

tessuto acrilico
acrylic fabric

ref.
ref.

€
€

aria

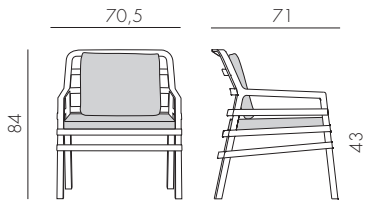

7,9



1
0,261 m³



8 pz



CADIS

	BIANCO		LIME	40330.00.061.061	€ 168,00
	BIANCO		CHERRY	40330.00.065.065	
	BIANCO		MELANZANA	40330.00.068.068	
	BIANCO		BIANCO *	40330.00.155.155	
	BIANCO		CAFFÈ	40330.00.165.165	
	BIANCO		ARANCIO	40330.00.166.166	
	BIANCO		GRIGIO *	40330.00.163.163	
	BIANCO		GRIGIO Sunbrella®	40330.00.136.136	
	ANTRACITE		LIME	40330.02.061.061	€ 168,00
	ANTRACITE		CHERRY	40330.02.065.065	
	ANTRACITE		MELANZANA	40330.02.068.068	
	ANTRACITE		BIANCO	40330.02.155.155	
	ANTRACITE		CAFFÈ	40330.02.165.165	
	ANTRACITE		ARANCIO	40330.02.166.166	
	ANTRACITE		GRIGIO *	40330.02.163.163	
	ANTRACITE		GRIGIO Sunbrella®	40330.02.136.136	
	CAFFÈ		LIME	40330.05.061.061	€ 168,00
	CAFFÈ		CHERRY	40330.05.065.065	
	CAFFÈ		MELANZANA	40330.05.068.068	
	CAFFÈ		BIANCO	40330.05.155.155	
	CAFFÈ		CAFFÈ *	40330.05.165.165	
	CAFFÈ		ARANCIO	40330.05.166.166	
	CAFFÈ		GRIGIO	40330.05.163.163	
	CAFFÈ		GRIGIO Sunbrella®	40330.05.136.136	
	ROSSO		LIME	40330.07.061.061	€ 168,00
	ROSSO		CHERRY	40330.07.065.065	
	ROSSO		MELANZANA	40330.07.068.068	
	ROSSO		BIANCO	40330.07.155.155	
	ROSSO		CAFFÈ	40330.07.165.165	
	ROSSO		ARANCIO	40330.07.166.166	
	ROSSO		GRIGIO	40330.07.163.163	
	ROSSO		GRIGIO Sunbrella®	40330.07.136.136	
	TORTORA		LIME	40330.10.061.061	
	TORTORA		CHERRY	40330.10.065.065	
	TORTORA		MELANZANA	40330.10.068.068	

modello
model



























info
info

colore
colour

tessuto acrilico
acrylic fabric

ref.
ref.

€
€

aria					
modello	info	colore	tessuto acrilico	ref.	€
		 TORTORA	 BIANCO	40330.10.155.155	€ 168,00
		 TORTORA	 CAFFÈ *	40330.10.165.165	
		 TORTORA	 ARANCIO	40330.10.166.166	
		 TORTORA	 GRIGIO	40330.10.163.163	
		 TORTORA	 GRIGIO Sunbrella®	40330.10.136.136	€ 224,50
		 AVANA	 LIME	40330.33.061.061	€ 168,00
		 AVANA	 CHERRY	40330.33.065.065	
		 AVANA	 MELANZANA	40330.33.068.068	
		 AVANA	 BIANCO	40330.33.155.155	
		 AVANA	 CAFFÈ *	40330.33.165.165	
		 AVANA	 ARANCIO	40330.33.166.166	
		 AVANA	 GRIGIO	40330.33.163.163	
		 AVANA	 GRIGIO Sunbrella®	40330.33.136.136	

* Disponibile a magazzino. Le altre versioni su ordinazione
Available ex-stock. Other versions available on order

modello
model

info
info

colore
colour

ref.
ref.

€
€

palma

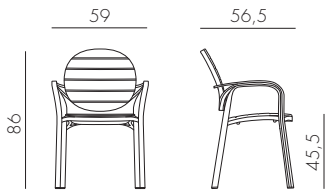

PP



5,4



6
0,551 m³



24 pz



CADIS



BIANCO



BIANCO

40237.00.000



BIANCO



TORTORA

40237.00.010



ANTRACITE



ANTRACITE

40237.02.002



CAFFÈ



CAFFÈ

40237.05.005



TORTORA



TORTORA

40237.10.010

€ 68,50

erica

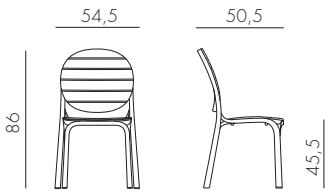

PP



4,2



22
1,453 m³



22 pz



CADIS



BIANCO



BIANCO

40236.00.000



BIANCO



TORTORA

40236.00.010



ANTRACITE



ANTRACITE

40236.02.002



CAFFÈ



CAFFÈ

40236.05.005



TORTORA



TORTORA

40236.10.010

€ 63,50

zac classic

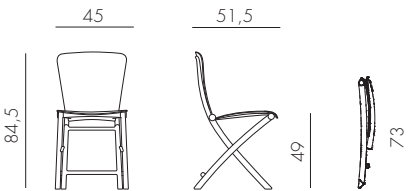

PP-F



4



1
0,039 m³



36 pz



CADIS



BIANCO

40324.00.000



GRIGIO

40324.03.000



TORTORA

40324.10.000



LIME

40324.12.000



ARANCIO

40324.26.000

€ 57,00

zac spring

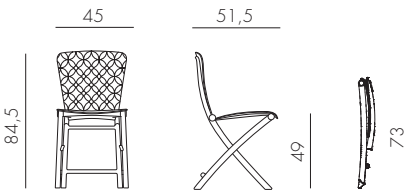

PP-F



4,3



1
0,039 m³



36 pz



CADIS



BIANCO

40325.00.000



ANTRACITE

40325.02.000



ROSSO

40325.07.000



LIME

40325.12.000



ARANCIO

40325.26.000

€ 57,00

SEDUTE IN
POLIPROPILENE
E ALLUMINIO

polypropylene and
aluminium seats

modello
model

info
info

colore
colour

gambe in alluminio
aluminium legs

ref.
ref.

€
€

ninfea dinner

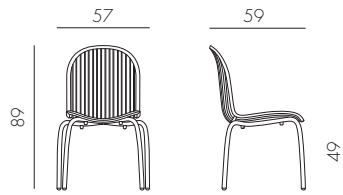

Kg 4,5
C 6
0,257 m³
48 pz
CADAS

■ ANTRACITE	■ ANODIZZATO	62050.02.000
■ CAFFÈ	■ ANODIZZATO	62050.05.000
■ BIANCO	■ VERN. BIANCO	62053.00.000

€ 92,00

ninfea relax

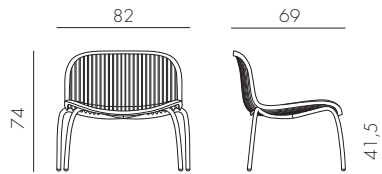

Kg 7,2
C 2
0,248 m³
20 pz
CADAS

■ ANTRACITE	■ ANODIZZATO	62250.02.000
■ CAFFÈ	■ ANODIZZATO	62250.05.000
■ BIANCO	■ VERN. BIANCO	62253.00.000

€ 128,00

dama *

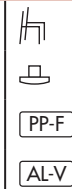
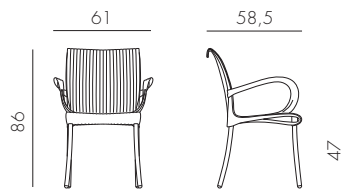

Kg 3,9
F 18
1,450 m³
18 pz
CADAS

■ ANTRACITE	■ VERN. ANTRACITE	61652.02.000
■ CAFFÈ	■ VERN. CAFFÈ	61657.05.000
■ BURRO	■ VERN. BURRO	61658.28.000
■ TORTORA	■ VERN. TORTORA	61659.10.000

€ 65,00

regina *

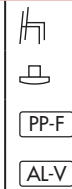
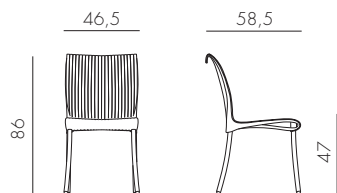

Kg 3,1
F 18
1,392 m³
18 pz
CADAS

■ ANTRACITE	■ VERN. ANTRACITE	61852.02.000
■ CAFFÈ	■ VERN. CAFFÈ	61857.05.000
■ BURRO	■ VERN. BURRO	61858.28.000
■ TORTORA	■ VERN. TORTORA	61859.10.000

€ 61,00

duca *

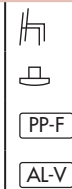
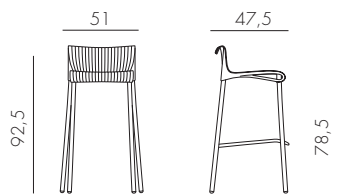

Kg 3,6
C 4
0,347 m³
32 pz
CADAS

■ ANTRACITE	■ VERN. ANTRACITE	75252.02.000
■ CAFFÈ	■ VERN. CAFFÈ	75257.05.000
■ BURRO	■ VERN. BURRO	75258.28.000
■ TORTORA	■ VERN. TORTORA	75259.10.000

€ 116,00

* nuova versione
new version

modello
model

info
info

colore
colour

gambe in alluminio
aluminium legs

ref.
ref.

€

alaska

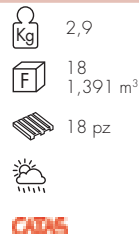
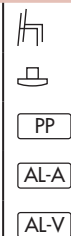
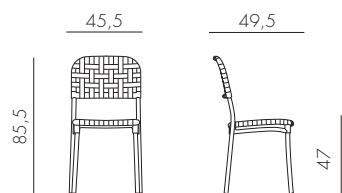

BIANCO	ANODIZZATO	60450.00.000
ANTRACITE	ANODIZZATO	60450.02.000
CAFFÈ	ANODIZZATO	60450.05.000
ANTRACITE	VERN. ANTRACITE	60452.02.000

€ 68,00

aurora

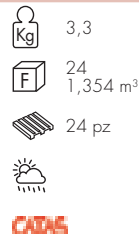
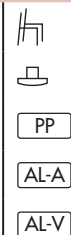
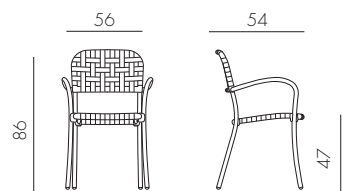

BIANCO	ANODIZZATO	60250.00.000
ANTRACITE	ANODIZZATO	60250.02.000
CAFFÈ	ANODIZZATO	60250.05.000
ANTRACITE	VERN. ANTRACITE	60252.02.000

€ 84,50

globo

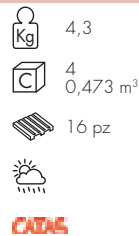
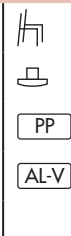
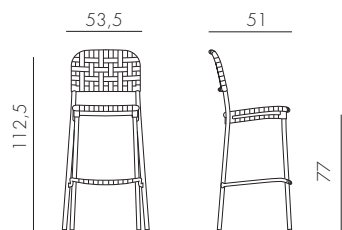

BIANCO	VERN. ARGENTO	75454.00.000
ANTRACITE	VERN. ARGENTO	75454.02.000
CAFFÈ	VERN. ARGENTO	75454.05.000
ANTRACITE	VERN. ANTRACITE	75452.02.000

€ 125,00

artica

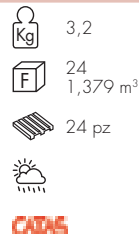
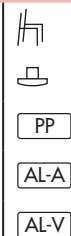
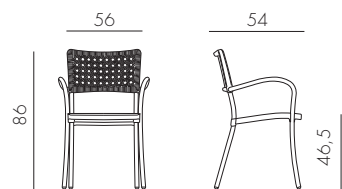

PAGLIA	ANODIZZATO	60050.29.000
PAGLIA	VERN. ANTRACITE	60052.29.000

€ 101,00

artica wicker

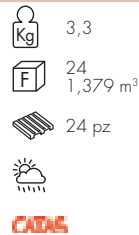
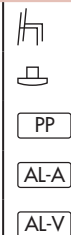
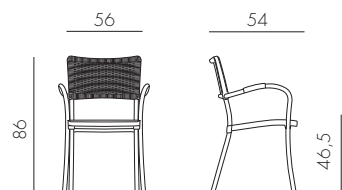

ANTRACITE	ANODIZZATO	60150.02.000
CAFFÈ	ANODIZZATO	60150.05.000
ANTRACITE	VERN. ANTRACITE	60152.02.000

€ 84,50

musa

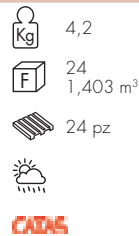
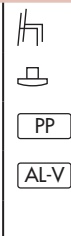
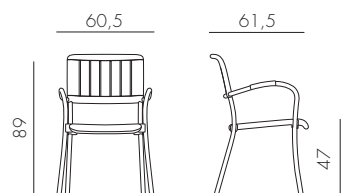

BIANCO	VERN. BIANCO	61053.00.000
ANTRACITE	VERN. ANTRACITE	61052.02.000
CAFFÈ	VERN. CAFFÈ	61057.05.000
TORTORA	VERN. TORTORA	61059.10.000

€ 89,50

modello
model

info
info

colore
colour

gambe in alluminio
aluminium legs

ref.
ref.

€
€

regina meeting

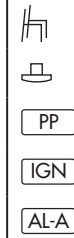
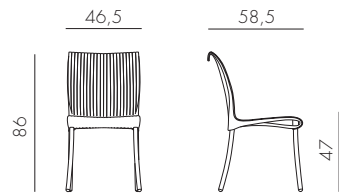

■ ANTRACITE	■ ANODIZZATO	61950.02.000
■ CAFFÈ	■ ANODIZZATO	61950.05.000
■ ROSSO	■ ANODIZZATO	61950.07.000
■ BURRO	■ ANODIZZATO	61950.28.000

€ 68,00

distanziali regina meeting



206180303

€ 2,80

staffa a terra regina meeting

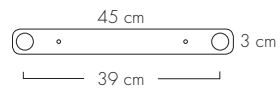

16618010

€ 11,00

LETTINI

sunloungers

modello
model

info
info

colore struttura
frame colour

tessuto sintetico
synthetic fabric

ref.
ref.

€
€

atlantico

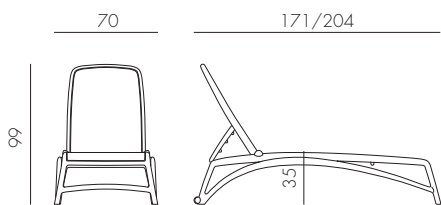

16
20
2,744 m³
20 pz
CADS

	BIANCO		ROSA	40450.00.056
	BIANCO		CELESTE	40450.00.075
	BIANCO		MANDARINO	40450.00.083
	BIANCO		PRATO	40450.00.084
	BIANCO		BLU	40450.00.102
	BIANCO		TORTORA	40450.00.104
	BIANCO		BIANCO	40450.00.107
	ANTRACITE		ANTRACITE	40450.02.057
	ANTRACITE		CELESTE	40450.02.075
	CAFFÈ		TORTORA	40450.05.104
	CAFFÈ		PRATO	40450.05.084
	CAFFÈ		CELESTE	40450.05.075
	TORTORA		CELESTE	40450.10.075
	TORTORA		TORTORA	40450.10.104
	TORTORA		BIANCO	40450.10.107

€ 262,00

bracciolo atlantico

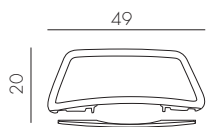

PP-F

1,1
1
0,013 m³
160 pz

	BIANCO			40452.00.000
	ANTRACITE			40452.02.000
	CAFFÈ			40452.05.000
	TORTORA			40452.10.000

€ 24,00

modello
model

info
info

colore struttura
frame colour

tessuto sintetico
synthetic fabric

ref.
ref.

€
€

alfa

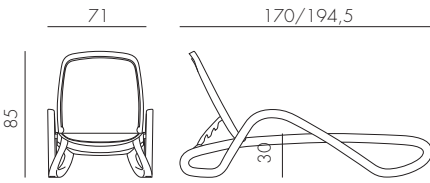

14
17
3,041 m³
17 pz
CADAS

<input type="checkbox"/> BIANCO	<input type="checkbox"/> BIANCO	40416.00.108	€ 189,50
<input type="checkbox"/> BIANCO	<input type="checkbox"/> BLU	40416.00.112	
<input type="checkbox"/> BIANCO	<input type="checkbox"/> BEIGE	40416.00.115	
<input type="checkbox"/> BIANCO	<input type="checkbox"/> TORTORA	40416.00.124	€ 199,00
<input type="checkbox"/> BIANCO	<input type="checkbox"/> TRAMA BEIGE	40416.00.078	
<input type="checkbox"/> BIANCO	<input type="checkbox"/> TRAMA BIANCO	40416.00.121	
<input type="checkbox"/> CAFFÈ	<input type="checkbox"/> BEIGE	40416.05.115	€ 210,50
<input type="checkbox"/> TORTORA	<input type="checkbox"/> TORTORA	40416.10.124	
<input type="checkbox"/> ANTRACITE	<input type="checkbox"/> TRAMA BEIGE	40416.02.078	
<input type="checkbox"/> ANTRACITE	<input type="checkbox"/> TRAMA ANTRAC.	40416.02.116	€ 220,00
<input type="checkbox"/> CAFFÈ	<input type="checkbox"/> TRAMA BEIGE	40416.05.078	
<input type="checkbox"/> CAFFÈ	<input type="checkbox"/> TRAMA CAFFÈ	40416.05.117	
<input type="checkbox"/> TORTORA	<input type="checkbox"/> TRAMA BIANCO	40416.10.121	

omega

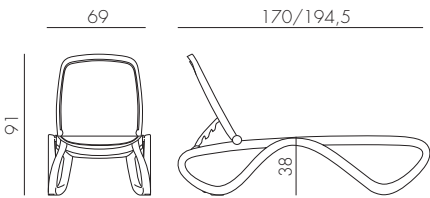

14,3
18
3,102 m³
18 pz
CADAS

<input type="checkbox"/> BIANCO	<input type="checkbox"/> BIANCO	40417.00.108	€ 189,50
<input type="checkbox"/> BIANCO	<input type="checkbox"/> BLU	40417.00.112	
<input type="checkbox"/> BIANCO	<input type="checkbox"/> BEIGE	40417.00.115	
<input type="checkbox"/> BIANCO	<input type="checkbox"/> TORTORA	40417.00.124	€ 199,00
<input type="checkbox"/> BIANCO	<input type="checkbox"/> TRAMA BEIGE	40417.00.078	
<input type="checkbox"/> BIANCO	<input type="checkbox"/> TRAMA BIANCO	40417.00.121	
<input type="checkbox"/> CAFFÈ	<input type="checkbox"/> BEIGE	40417.05.115	€ 210,50
<input type="checkbox"/> TORTORA	<input type="checkbox"/> TORTORA	40417.10.124	
<input type="checkbox"/> ANTRACITE	<input type="checkbox"/> TRAMA BEIGE	40417.02.078	
<input type="checkbox"/> ANTRACITE	<input type="checkbox"/> TRAMA ANTRAC.	40417.02.116	€ 220,00
<input type="checkbox"/> CAFFÈ	<input type="checkbox"/> TRAMA BEIGE	40417.05.078	
<input type="checkbox"/> CAFFÈ	<input type="checkbox"/> TRAMA CAFFÈ	40417.05.117	
<input type="checkbox"/> TORTORA	<input type="checkbox"/> TRAMA BIANCO	40417.10.121	

modello
model

info
info

colore struttura
frame colour

tessuto sintetico
synthetic fabric

ref.
ref.

€
€

eden

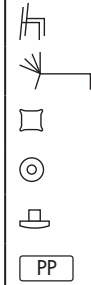
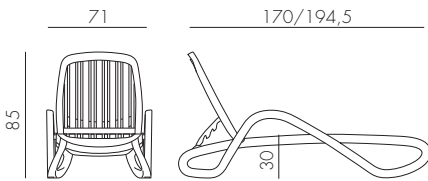

14,7
 17
3,041 m³
 17 pz

CADIS

BIANCO		40414.00.000	€ 131,00
ANTRACITE		40414.02.000	€ 144,00
CAFFÈ		40414.05.000	
TORTORA		40414.10.000	

tropico

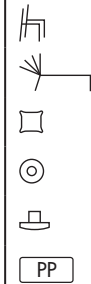
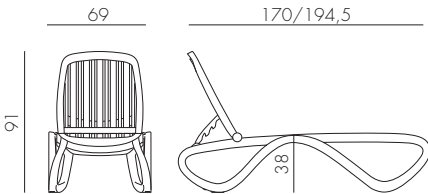

15,1
 18
3,102 m³
 18 pz

CADIS

BIANCO		40413.00.000	€ 131,00
ANTRACITE		40413.02.000	€ 144,00
CAFFÈ		40413.05.000	
TORTORA		40413.10.000	

parasole (alfa-omega-eden-tropico)

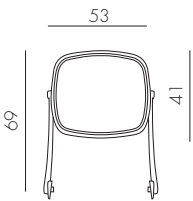

1,4
 1
0,015 m³
 80 pz

BIANCO	BIANCO	40418.00.108	€ 42,50
BIANCO	BLU	40418.00.112	
BIANCO	BEIGE	40418.00.115	
BIANCO	TORTORA	40418.00.124	€ 45,00
BIANCO	TRAMA BEIGE	40418.00.078	
BIANCO	TRAMA BIANCO	40418.00.121	
CAFFÈ	BEIGE	40418.05.115	€ 46,00
TORTORA	TORTORA	40418.10.124	
ANTRACITE	TRAMA BEIGE	40418.02.078	
ANTRACITE	TRAMA ANTRAC.	40418.02.116	€ 48,50
CAFFÈ	TRAMA BEIGE	40418.05.078	
CAFFÈ	TRAMA CAFFÈ	40418.05.117	
TORTORA	TRAMA BIANCO	40418.10.121	

modello
model

info
info

colore struttura
frame colour

tessuto sintetico
synthetic fabric

ref.
ref.

€
€

ricambio atlantico

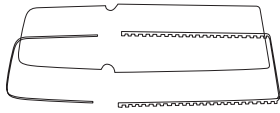

# PP 1,3 1 0,046 m ³ 50 pz 	<input type="checkbox"/> BIANCO	<input type="checkbox"/> ROSA	40460.00.056	€ 85,00
	<input type="checkbox"/> BIANCO	<input type="checkbox"/> CELESTE	40460.00.075	
	<input type="checkbox"/> BIANCO	<input type="checkbox"/> MANDARINO	40460.00.083	
	<input type="checkbox"/> BIANCO	<input type="checkbox"/> PRATO	40460.00.084	
	<input type="checkbox"/> BIANCO	<input type="checkbox"/> BLU	40460.00.102	
	<input type="checkbox"/> BIANCO	<input type="checkbox"/> TORTORA	40460.00.104	
	<input type="checkbox"/> BIANCO	<input type="checkbox"/> BIANCO	40460.00.107	
	<input type="checkbox"/> NERO	<input type="checkbox"/> ANTRACITE	40460.01.057	
	<input type="checkbox"/> NERO	<input type="checkbox"/> CELESTE	40460.01.075	
	<input type="checkbox"/> NERO	<input type="checkbox"/> PRATO	40460.01.084	
	<input type="checkbox"/> NERO	<input type="checkbox"/> TORTORA	40460.01.104	

ricambio alfa-omega

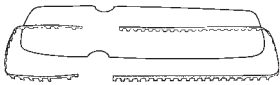

# PP 1,6 1 0,046 m ³ 50 pz 	<input type="checkbox"/> BIANCO	<input type="checkbox"/> BIANCO	40424.01.108	€ 66,50
	<input type="checkbox"/> BIANCO	<input type="checkbox"/> BEIGE	40424.01.115	
	<input type="checkbox"/> BIANCO	<input type="checkbox"/> TORTORA	40424.00.124	€ 79,00
	<input type="checkbox"/> BIANCO	<input type="checkbox"/> TRAMA BEIGE	40424.01.078	
	<input type="checkbox"/> BIANCO	<input type="checkbox"/> TRAMA BIANCO	40424.00.121	€ 66,50
	<input type="checkbox"/> NERO	<input type="checkbox"/> BLU	40424.00.112	
	<input type="checkbox"/> NERO	<input type="checkbox"/> TORTORA	40424.01.124	€ 79,00
	<input type="checkbox"/> NERO	<input type="checkbox"/> BEIGE	40424.00.115	
	<input type="checkbox"/> NERO	<input type="checkbox"/> TRAMA BEIGE	40424.00.078	€ 79,00
	<input type="checkbox"/> NERO	<input type="checkbox"/> TRAMA ANTRAC.	40424.00.116	
	<input type="checkbox"/> NERO	<input type="checkbox"/> TRAMA CAFFÈ	40424.00.117	

stampa logo personalizzato/printing of personalized logo

Stampa LOGO a 1 colore sui lettini Alfa, Omega, Atlantico e sul parasole (NON POSSIBILE sul tessuto TRAMA)

Printing of 1 single colour LOGO on Alfa Omega Atlantico sunloungers and on sunshades (NOT possible on the TRAMA fabric)

Costo fisso per impianto/ Fixed cost for plant		€ 330,00
Quantità/Quantity		
da/from	a/to	
30 pz minimo/pcs minimum	100 pz/pcs	€ 8,30
101 pz/pcs	300 pz/pcs	€ 6,70
301 pz/pcs	1000 pz/pcs	€ 5,20
oltre/over 1000 pz/pcs		€ 4,20

TAVOLI IN
POLIPROPILENE

polypropylene tables

modello
model

info
info

colore
colour

ref.
ref.

€
€

clip **new**

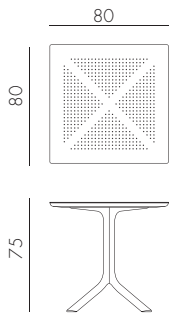

PP-F

DT



12,1



1
0,108 m³



15 pz



CADIS



BIANCO

40082.00.000



ANTRACITE

40082.02.000



TORTORA

40082.10.000



AVANA

40082.33.000

€ 169,00

step

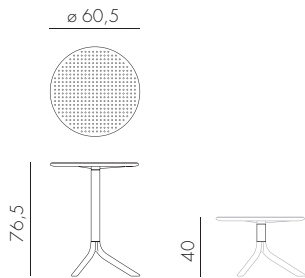

PP-F



4,2



1
0,129 m³



24 pz



BIANCO

40056.00.000



ANTRACITE

40056.02.000



CAFFÈ

40056.05.000



ROSSO

40056.07.000



TORTORA

40056.10.000



ARANCIO

40056.26.000



AVANA

40056.33.000



CELESTE

40056.39.000

€ 68,50

spritz

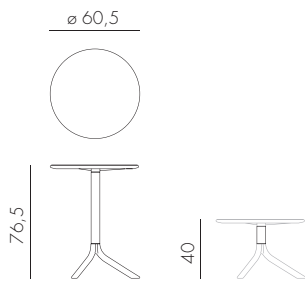

PP-F



4,3



1
0,129 m³



24 pz



BIANCO

40058.00.000



ANTRACITE

40058.02.000



CAFFÈ

40058.05.000



ROSSO

40058.07.000



TORTORA

40058.10.000



LIME

40058.12.000



ARANCIO

40058.26.000



CELESTE

40058.39.000

€ 68,50

modello
model

info
info

colore
colour

ref.
ref.

€
€

aria 100

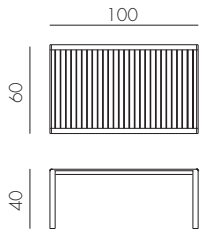

PP



8



1
0,072 m³



40 pz



CADAS

BIANCO

40052.00.000

ANTRACITE

40052.02.000

CAFFÈ

40052.05.000

ROSSO

40052.07.000

TORTORA

40052.10.000

AVANA

40052.33.000

€ 85,00

aria 60

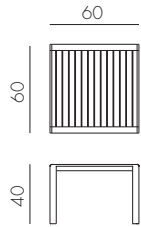

PP



5



1
0,047 m³



72 pz



CADAS

BIANCO

40051.00.000

ANTRACITE

40051.02.000

CAFFÈ

40051.05.000

ROSSO

40051.07.000

TORTORA

40051.10.000

AVANA

40051.33.000

€ 64,00

pop new

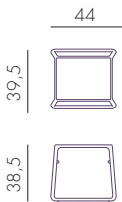

PP-F



1,4



4
0,140 m³



48 pz

CADAS

BIANCO

40048.00.000

ANTRACITE

40048.02.000

CAFFÈ

40048.05.000

TORTORA

40048.10.000

€ 49,00

rodi

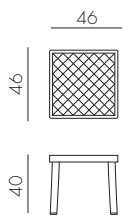

PP



2,3



7
0,103 m³



140 pz

CADAS

BIANCO

40050.00.000

ANTRACITE

40050.02.000

CAFFÈ

40050.05.000

TORTORA

40050.10.000

€ 24,50

€ 26,50

**TAVOLI IN
POLIPROPILENE
E ALLUMINIO**

polypropylene and
aluminium tables

modello
model

info
info

colore piano
top colour

gambe in alluminio
aluminium legs

ref.
ref.

€
€

rio new

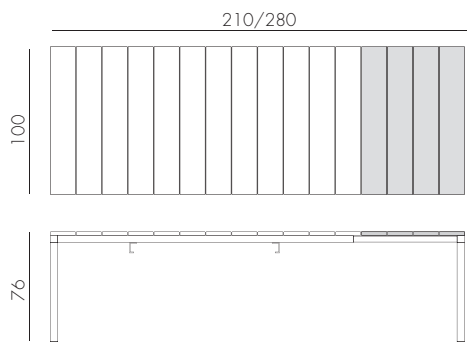

49
 1
0,315 m³
 15 pz
 CADIS

BIANCO	VERN. BIANCO	48253.00.000
ANTRACITE	VERN. ANTRACITE	48252.02.000
TORTORA	VERN. TORTORA	48259.10.000

€ 780,00

alloro 210 extensible

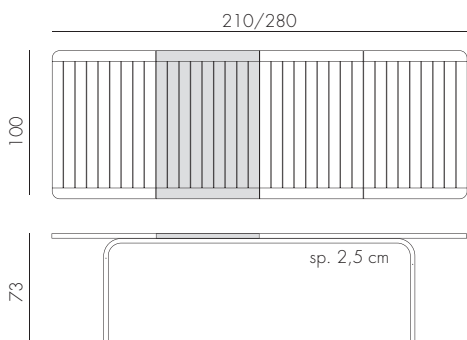

44,4
 1
0,203 m³
 13 pz
 CADIS

BIANCO	VERN. BIANCO	42853.00.000
TORTORA	VERN. BIANCO	42853.10.000
ANTRACITE	VERN. ANTRACITE	42852.02.000
CAFFÈ	VERN. CAFFÈ	42857.05.000
TORTORA	VERN. TORTORA	42859.10.000

€ 659,00

alloro 140 extensible

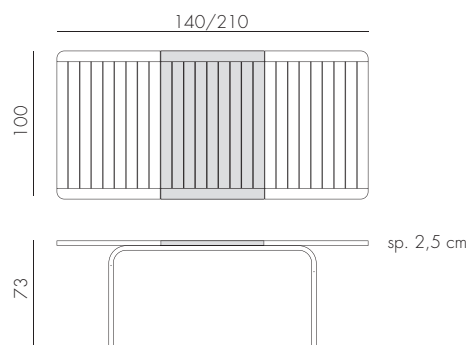

33,7
 1
0,155 m³
 18 pz
 CADIS

BIANCO	VERN. BIANCO	42753.00.000
TORTORA	VERN. BIANCO	42753.10.000
ANTRACITE	VERN. ANTRACITE	42752.02.000
CAFFÈ	VERN. CAFFÈ	42757.05.000
TORTORA	VERN. TORTORA	42759.10.000

€ 528,50

modello
model

info
info

colore piano
top colour

gambe in alluminio
aluminium legs

ref.
ref.

€
€

libeccio

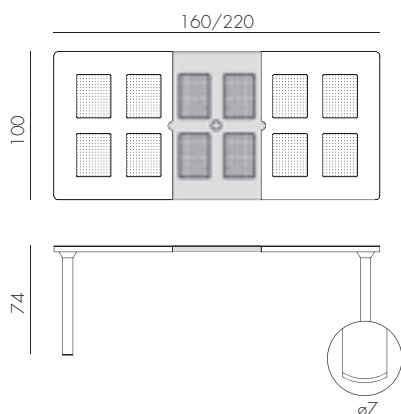

PP

DT

AL-V



28,8



1
0,193 m³



14 pz



CADIS

BIANCO

VERN. BIANCO

47553.00.000

ANTRACITE

VERN. ANTRACITE

47552.02.000

CAFFÈ

VERN. CAFFÈ

47557.05.000

TORTORA

VERN. TORTORA

47559.10.000

€ 422,50

levante

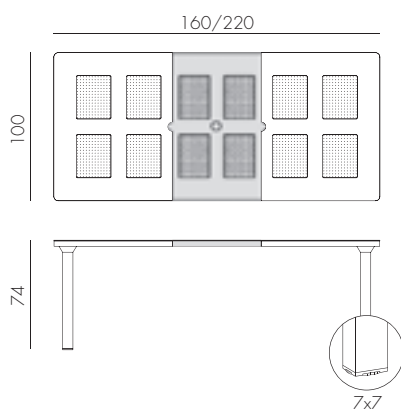

PP

DT

AL-V



29,6



1
0,193 m³



14 pz



CADIS

BIANCO

VERN. BIANCO

47053.00.000

ANTRACITE

VERN. ANTRACITE

47052.02.000

CAFFÈ

VERN. CAFFÈ

47057.05.000

TORTORA

VERN. TORTORA

47059.10.000

€ 422,50

maestrale 220

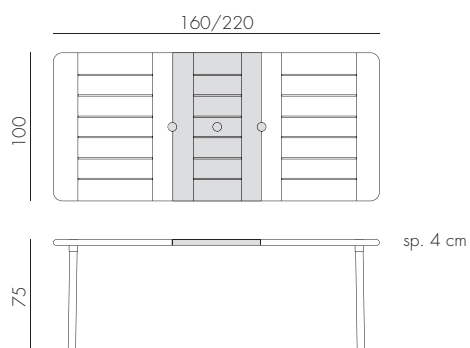

PP

DT

AL-V



31,3



1
0,157 m³



15 pz



CADIS

BIANCO

VERN. BIANCO

42253.00.000

ANTRACITE

VERN. ANTRACITE

42252.02.000

CAFFÈ

VERN. CAFFÈ

42257.05.000

TORTORA

VERN. TORTORA

42259.10.000

€ 398,00

modello
model

info
info

colore piano
top colour

gambe in alluminio
aluminium legs

ref.
ref.

€
€

maestrale 90

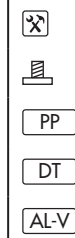
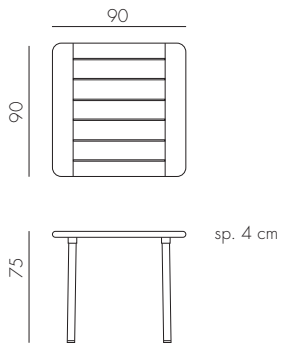

11,7
 1
0,086 m³
 24 pz
 CADIS

colore piano	gambe in alluminio	ref.
BIANCO	VERN. BIANCO	42053.00.000
ANTRACITE	VERN. ANTRACITE	42052.02.000
CAFFÈ	VERN. CAFFÈ	42057.05.000
TORTORA	VERN. TORTORA	42059.10.000

€ 174,50

cube

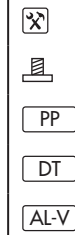
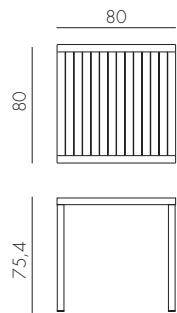

11,5
 1
0,061 m³
 18 pz
 CADIS

colore piano	gambe in alluminio	ref.
BIANCO	VERN. BIANCO	48053.00.000
ANTRACITE	VERN. ANTRACITE	48052.02.000
CAFFÈ	VERN. CAFFÈ	48057.05.000
TORTORA	VERN. TORTORA	48059.10.000

€ 199,00

TAVOLI LOTO

loto tables

modello
model

info
info

colore piano
colour top

gambe in alluminio
aluminium legs

ref.
ref.

€
€

loto dinner 190

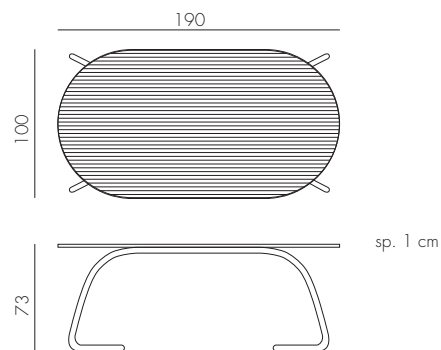

AL-A

AL-V

V-T-S



49,8



1
0,227 m³



10 pz



CADIS

■ ANTRACITE

■ CAFFÈ

□ BIANCO

■ ANODIZZATO

■ ANODIZZATO

■ VERN. BIANCO

44050.02.000

44050.05.000

44053.00.000

€ 717,50

loto dinner ø170

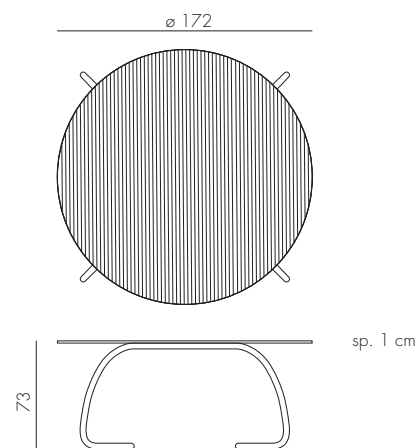

AL-A

AL-V

V-T-S



65,3



1
1,026 m³



1 pz



CADIS

■ ANTRACITE

■ CAFFÈ

□ BIANCO

■ ANODIZZATO

■ ANODIZZATO

■ VERN. BIANCO

44450.02.000

44450.05.000

44453.00.000

€ 1 302,00

loto dinner ø120

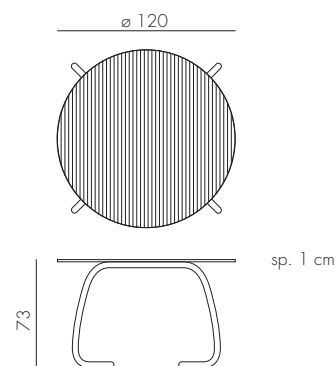

AL-A

AL-V

V-T-S



34



1
0,182 m³



10 pz



CADIS

■ ANTRACITE

■ CAFFÈ

□ BIANCO

■ ANODIZZATO

■ ANODIZZATO

■ VERN. BIANCO

44350.02.000

44350.05.000

44353.00.000

€ 629,50

modello
model

info
info

colore piano
colour top

gambe in alluminio
aluminium legs



ref.
ref.



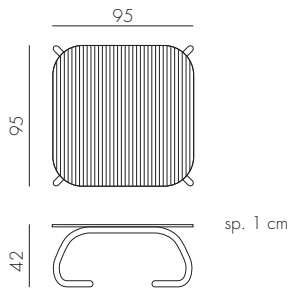

€
€

loto relax 95



-  
- AL-A**
- AL-V**
- V-T-S**

-  27
-  1
0,143 m³
-  10 pz
- 
- CADIS**



 ANTRACITE	 ANODIZZATO	44750.02.000
 CAFFÈ	 ANODIZZATO	44750.05.000
 BIANCO	 VERN. BIANCO	44753.00.000



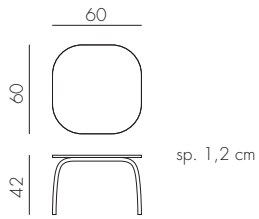

€ 497,00

loto relax 60



-  
- AL-A**
- AL-V**
- LAM**

-  7
-  1
0,019 m³
-  30 pz
- 
- CADIS**

 ANTRACITE	 ANODIZZATO	44650.00.303
 CAFFÈ	 ANODIZZATO	44650.00.302
 BIANCO	 VERN. BIANCO	44653.00.301

€ 221,00

TAVOLI POLO

polo tables

modello
model

info
info

colore piano
colour top

poliprop./gambe in alluminio
polyprop./aluminium legs

ref.
ref.

€
€

polo 70x70 durelTOP

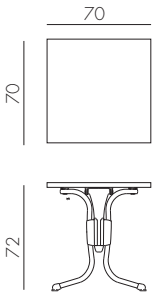

 CADIS	 8,4 1 0,069 m ³ 15 pz	BIANCO	BIANCO/ANODIZZATO	50750.00.400	€ 162,00
		GRIGIO	ANTRAC./ANODIZZATO	50750.02.403	
		GRIGIO	GRIGIO/ANODIZZATO	50750.03.403	
		GRIGIO	CAFFÈ /ANODIZZATO	50750.05.403	
		ANTRACITE*	ANTRACITE/VERN. ANTRAC.	50752.02.402	

polo 80x80 durelTOP

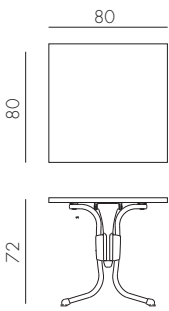

 CADIS	 8,6 1 0,083 m ³ 15 pz	BIANCO	BIANCO/ANODIZZATO	50850.00.400	€ 187,00
		GRIGIO	ANTRAC./ANODIZZATO	50850.02.403	
		GRIGIO	GRIGIO/ANODIZZATO	50850.03.403	
		GRIGIO	CAFFÈ /ANODIZZATO	50850.05.403	
		ANTRACITE*	ANTRACITE/VERN. ANTRAC.	50852.02.402	

* Piani da utilizzare solo in zone ombreggiate
Only use table tops in shaded areas

modello
model

info
info

colore piano
colour top

poliprop./gambe in alluminio
polyprop./aluminium legs

ref.
ref.

€
€

polo ø60 werzalit-topalit

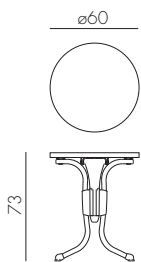

 CADIS PP W-T AL-A AL-V	 8,6 1 0,056 m ³ 15 pz CADIS	 BIANCO	 BIANCO/ANODIZZATO	51650.00.190	€ 149,50
		 ARGENTO.	 ANTRAC./ANODIZZATO	51650.02.197	
		 ARGENTO	 GRIGIO/ANODIZZATO	51650.03.197	
		 ARGENTO	 CAFFÈ /ANODIZZATO	51650.05.197	

polo ø70 werzalit-topalit

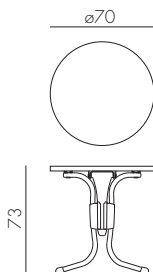

 CADIS PP W-T AL-A AL-V	 9 1 0,063 m ³ 15 pz CADIS	 BIANCO	 BIANCO/ANODIZZATO	51750.00.190	€ 165,00
		 ARGENTO.	 ANTRAC./ANODIZZATO	51750.02.197	
		 ARGENTO	 GRIGIO/ANODIZZATO	51750.03.197	
		 ARGENTO	 CAFFÈ /ANODIZZATO	51750.05.197	
		 GRANITO *	 ANTRACITE/VERN. ANTRAC.	51752.02.189	

polo ø80 werzalit-topalit

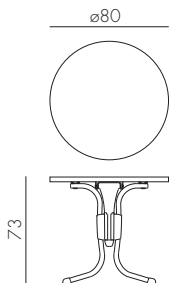

 CADIS PP W-T AL-A AL-V	 11,1 1 0,080 m ³ 15 pz CADIS	 BIANCO	 BIANCO/ANODIZZATO	51850.00.190	€ 177,50
		 ARGENTO.	 ANTRAC./ANODIZZATO	51850.02.197	
		 ARGENTO	 GRIGIO/ANODIZZATO	51850.03.197	
		 ARGENTO	 CAFFÈ /ANODIZZATO	51850.05.197	
		 GRANITO *	 ANTRACITE/VERN. ANTRAC.	51852.02.189	

* Piani da utilizzare solo in zone ombreggiate
 Only use table tops in shaded areas

modello
model

info
info

colore piano
colour top

poliprop./gambe in alluminio
polyprop./aluminium legs

ref.
ref.

€
€

polo 60X60 werzalit-topalit

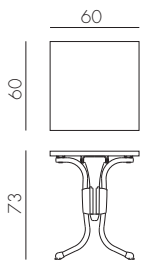

 	8,6 1 0,056 m ³ 15 pz	BIANCO	BIANCO/ANODIZZATO	50650.00.190	€ 172,50
		ARGENTO	ANTRAC./ANODIZZATO	50650.02.197	
		ARGENTO	GRIGIO/ANODIZZATO	50650.03.197	
		ARGENTO	CAFFÈ /ANODIZZATO	50650.05.197	
		GRANITO *	ANTRACITE/VERN. ANTRAC.	50652.02.189	

polo 70X70 werzalit-topalit

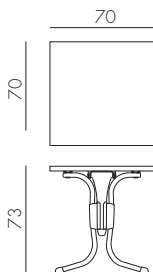

 	10,2 1 0,069 m ³ 15 pz	BIANCO	BIANCO/ANODIZZATO	50750.00.190	€ 203,00
		ARGENTO	ANTRAC./ANODIZZATO	50750.02.197	
		ARGENTO	GRIGIO/ANODIZZATO	50750.03.197	
		ARGENTO	CAFFÈ /ANODIZZATO	50750.05.197	
		GRANITO *	ANTRACITE/VERN. ANTRAC.	50752.02.189	

polo 80X80 werzalit-topalit

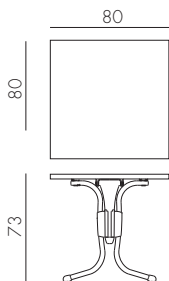

 	12,7 1 0,083 m ³ 15 pz	BIANCO	BIANCO/ANODIZZATO	50850.00.190	€ 219,00
		ARGENTO	ANTRAC./ANODIZZATO	50850.02.197	
		ARGENTO	GRIGIO/ANODIZZATO	50850.03.197	
		ARGENTO	CAFFÈ /ANODIZZATO	50850.05.197	
		GRANITO *	ANTRACITE/VERN. ANTRAC.	50852.02.189	

* Piani da utilizzare solo in zone ombreggiate
Only use table tops in shaded areas

modello
model

info
info

colore piano
colour top

poliprop./gambe in alluminio
polyprop./aluminium legs

ref.
ref.

€
€

polo 110X70 werzalit-topalit

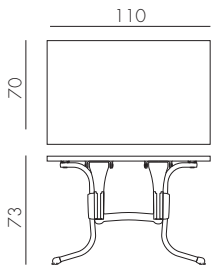

        	 16,7  1 0,108 m ³  15 pz  CADAS	 BIANCO	 BIANCO/ANODIZZATO	51 150.00.190	€ 260,50
		 ARGENTO	 ANTRAC./ANODIZZATO	51 150.02.197	
		 ARGENTO	 GRIGIO/ANODIZZATO	51 150.03.197	
		 ARGENTO	 CAFFÈ /ANODIZZATO	51 150.05.197	

polo 120X80 werzalit-topalit

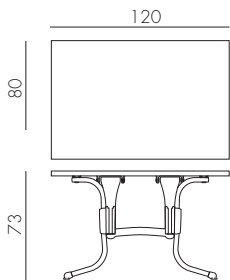

        	 20,1  1 0,124 m ³  15 pz  CADAS	 BIANCO	 BIANCO/ANODIZZATO	51 250.00.190	€ 295,50
		 ARGENTO	 ANTRAC./ANODIZZATO	51 250.02.197	
		 ARGENTO	 GRIGIO/ANODIZZATO	51 250.03.197	
		 ARGENTO	 CAFFÈ /ANODIZZATO	51 250.05.197	

**BASI IN
ALLUMINIO**

aluminium bases

modello
model

info
info

colore
colour

ref.
ref.

€
€

base scudo

Top ø60 - ø70 - ø80 - 60x60 - 70x70 - 80x80

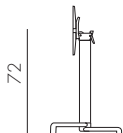
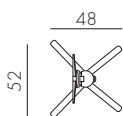

AL-V



5,8



1
0,026 m³



60 pz



CADIS



VERN. ANTRACITE

54052.00.000



VERN. BIANCO

54053.00.000



VERN. ARGENTO

54054.00.000



VERN. TORTORA

54059.00.000

€ 155,50

AL-ST



VERN. ANTRACITE

54052.00.000.01



VERN. BIANCO

54053.00.000.01



VERN. ARGENTO

54054.00.000.01



VERN. TORTORA

54059.00.000.01

€ 170,00

base scudo high

Top ø60 - ø70 - 60x60 - 70x70

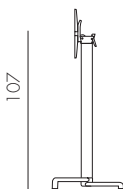
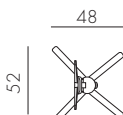

AL-V



6,7



1
0,064 m³



36 pz



CADIS



VERN. ANTRACITE

54152.00.000



VERN. ARGENTO

54154.00.000

AL-ST



VERN. ANTRACITE

54152.00.000.01



VERN. ARGENTO

54154.00.000.01

€ 174,50

€ 191,50

base scudo double

Top 110x70 - 120x80

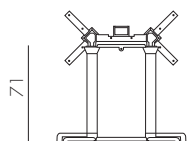
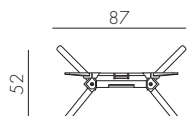

AL-V



8,7



1
0,030 m³



30 pz



CADIS



VERN. ANTRACITE

54352.00.000



VERN. ARGENTO

54354.00.000

AL-ST



VERN. ANTRACITE

54352.00.000.01



VERN. ARGENTO

54354.00.000.01

€ 234,00

€ 256,50

modello
model

info
info

colore
colour

ref.
ref.

€
€

base calice ALU

Top ø60 - ø70 - ø80 - 60x60 - 70x70 - 80x80

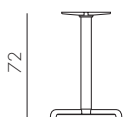
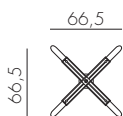

AL-V



4,5



1
0,017 m³



30 pz



CADIS



VERN. ANTRACITE

52652.00.000



VERN. BIANCO

52653.00.000



VERN. ARGENTO

52654.00.000



VERN. TORTORA

52659.00.000

€ 129,00

AL-ST



VERN. ANTRACITE

52652.00.000.01



VERN. BIANCO

52653.00.000.01



VERN. ARGENTO

52654.00.000.01



VERN. TORTORA

52659.00.000.01

€ 141,50

base calice ALU high

Top ø60 - ø70 - 60x60 - 70x70

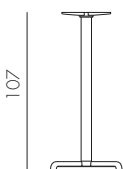
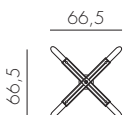

AL-V



5,5



1
0,064 m³



60 pz



CADIS



VERN. ANTRACITE

52752.00.000



VERN. BIANCO

52753.00.000



VERN. ARGENTO

52754.00.000

€ 149,00

AL-ST



VERN. ANTRACITE

52752.00.000.01



VERN. BIANCO

52753.00.000.01



VERN. ARGENTO

52754.00.000.01

€ 163,50

base ibisco

Top ø60 - ø70 - ø80 - 60x60 - 70x70 - 80x80

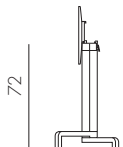
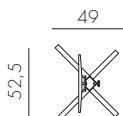

AL-V



6



1
0,026 m³



60 pz



CADIS



VERN. ANTRACITE

54552.00.000



VERN. BIANCO

54553.00.000



VERN. ARGENTO

54554.00.000



VERN. CAFFÈ

54557.00.000



VERN. TORTORA

54559.00.000

€ 155,50

base ibisco high

Top ø60 - ø70 - 60x60 - 70x70

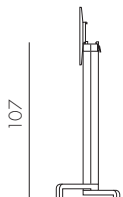
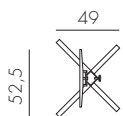

AL-V



6,7



1
0,064 m³



36 pz



CADIS



VERN. ANTRACITE

54652.00.000



VERN. BIANCO

54653.00.000



VERN. ARGENTO

54654.00.000



VERN. TORTORA

54659.00.000

€ 174,50

modello
model

info
info

colore
colour

ref.
ref.

€
€

base fiore

Top ø60 - ø70 - ø80 - 60x60 - 70x70 - 80x80

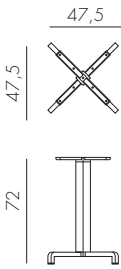

AL-V



5



1
0,017 m³



30 pz



CADIS



VERN. ANTRACITE

53052.00.000



VERN. BIANCO

53053.00.000



VERN. ARGENTO

53054.00.000



VERN. CAFFÈ

53057.00.000



VERN. TORTORA

53059.00.000

€ 129,00

base fiore high

Top ø60 - ø70 - 60x60 - 70x70

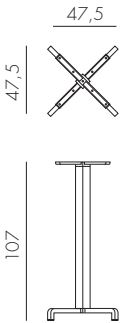

AL-V



5,7



1
0,064 m³



60 pz



CADIS



VERN. ANTRACITE

53152.00.000



VERN. BIANCO

53153.00.000



VERN. ARGENTO

53154.00.000



VERN. TORTORA

53159.00.000

€ 149,00

base flute

Top ø60 - ø70

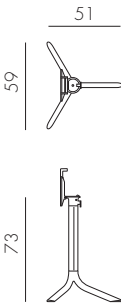

AL-V



4,8



1
0,073 m³



32 pz



CADIS



VERN. ANTRACITE

55652.00.000



VERN. BIANCO

55653.00.000



VERN. ARGENTO

55654.00.000



VERN. TORTORA

55659.00.000

€ 142,50

base break

Top ø60 - ø70

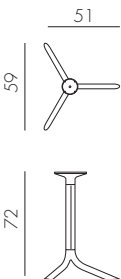

AL-V



4,3



1
0,073 m³



32 pz



CADIS



VERN. ANTRACITE

55852.00.000



VERN. BIANCO

55853.00.000



VERN. ARGENTO

55854.00.000



VERN. TORTORA

55859.00.000

€ 110,00

modello
model

info
info

colore
colour









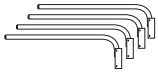

ref.
ref.

€
€

gambe iceberg 4

Top werzalitopalit ø60 - ø70 - ø80 - 60x60 - 70x70 - 80x80
Top DurellTOP 80x80

























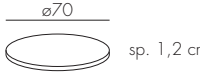





























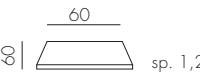





	 2,9	 ANODIZZATO	52550.00.000	€ 80,00
	 1 0,025 m ³	 VERN. ANTRACITE	52552.00.000	
 AL-A	 66 pz			
 AL-V				
				

PIANI

tops

PIANI LAMINATO / laminate tops (calice - scudo - scudo double - ibisco - fiore - flute - break)

modello model	info info	colore colour	ref. ref.	€ €
piano laminato ø60				
 <p>ø60 sp. 1,2 cm</p>	 	 4,5  2 0,017 m ³  60 pz 	 GRIGIO 30616.10.300	€ 99,50
			 BIANCO 30616.10.301	
			 CAFFÈ 30616.10.302	
			 ANTRACITE 30616.10.303	
			 CEMENTO 30616.10.305	
			 TORTORA 30616.10.310	
			 LEGNO 30616.10.311	
			 CORTEN 30616.10.312	
piano laminato ø70				
 <p>ø70 sp. 1,2 cm</p>	 	 6,2  2 0,023 m ³  60 pz 	 GRIGIO 30617.10.300	€ 132,00
			 BIANCO 30617.10.301	
			 CAFFÈ 30617.10.302	
			 ANTRACITE 30617.10.303	
			 CEMENTO 30617.10.305	
			 TORTORA 30617.10.310	
			 LEGNO 30617.10.311	
			 CORTEN 30617.10.312	
piano laminato ø80				
 <p>ø80 sp. 1,2 cm</p>	 	 8,1  2 0,030 m ³  60 pz 	 GRIGIO 30618.10.300	€ 167,50
			 BIANCO 30618.10.301	
			 CAFFÈ 30618.10.302	
			 ANTRACITE 30618.10.303	
			 CEMENTO 30618.10.305	
			 TORTORA 30618.10.310	
			 LEGNO 30618.10.311	
			 CORTEN 30618.10.312	
piano laminato 60X60				
 <p>60 sp. 1,2 cm</p>	 	 5,8  2 0,017 m ³  60 pz 	 GRIGIO 30606.10.300	€ 99,50
			 BIANCO 30606.10.301	
			 CAFFÈ 30606.10.302	
			 ANTRACITE 30606.10.303	
			 CEMENTO 30606.10.305	
			 TORTORA 30606.10.310	
			 LEGNO 30606.10.311	
			 CORTEN 30606.10.312	

modello
model

info
info

colore
colour

ref.
ref.

€
€

piano laminato 70X70

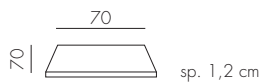

LAM



7,9



2
0,023 m³



60 pz



GRIGIO

30607.10.300



BIANCO

30607.10.301



CAFFÈ

30607.10.302



ANTRACITE

30607.10.303



CEMENTO

30607.10.305



TORTORA

30607.10.310



LEGNO

30607.10.311



CORTEN

30607.10.312

€ 132,00

piano laminato 80X80

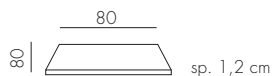

LAM



10,9



2
0,030 m³



60 pz



GRIGIO

30608.10.300



BIANCO

30608.10.301



CAFFÈ

30608.10.302



ANTRACITE

30608.10.303



CEMENTO

30608.10.305



TORTORA

30608.10.310



LEGNO

30608.10.311



CORTEN

30608.10.312

€ 167,50

piano laminato 110X70

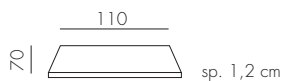

LAM



12,4



2
0,035 m³



40 pz



GRIGIO

30621.10.300



BIANCO

30621.10.301

€ 227,00

piano laminato 120X80

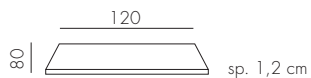

LAM



15,5



2
0,044 m³



40 pz



GRIGIO

30620.10.300











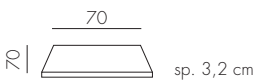
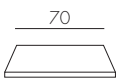











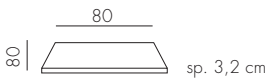
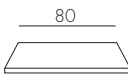



BIANCO

30620.10.301





















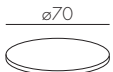









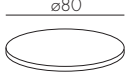









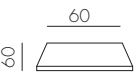









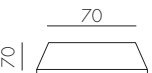







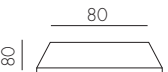

€ 266,00

PIANI DURELTOP / durelTop tops (calice - scudo - ibisco - fiore - iceberg 80x80)

modello model	info info	colore colour	ref. ref.	€ €	
piano durelTOP 70X70					
 <p>70  sp. 3,2 cm</p>	 	 3,9  1 0,020 m ³  40 pz 	 BIANCO	30207.00.400	€ 68,00
			 ANTRACITE *	30207.00.402	
			 GRIGIO	30207.00.403	
			 CAFFÈ *	30207.00.405	
			 TORTORA	30207.00.410	
piano durelTOP 80X80					
 <p>80  sp. 3,2 cm</p>	 	 7,2  1 0,030 m ³  40 pz 	 BIANCO	30208.00.400	€ 94,00
			 ANTRACITE *	30208.00.402	
			 GRIGIO	30208.00.403	
			 CAFFÈ *	30208.00.405	
			 TORTORA	30208.00.410	























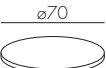











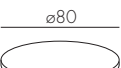











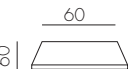











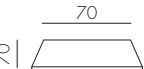

* Piani da utilizzare solo in zone ombreggiate
 Only use table tops in shaded areas

PIANI WERZALIT-TOPALIT CON AGGANCI / werzalit-topalit tops with hooks (gambe iceberg)

modello model	info info	colore colour	ref. ref.	€ €	
piano werzalit-topalit ø60 (iceberg)					
	 	 4,1  1 0,014 m ³  40 pz 	 BIANCO	30116.10.190	€ 65,00
			 CATALAN	30116.10.194	
			 ARGENTO	30116.10.197	
			 WICKER *	30116.10.198	
piano werzalit-topalit ø70 (iceberg)					
	 	 5,4  1 0,019 m ³  40 pz 	 BIANCO	30117.10.190	€ 80,50
			 CATALAN	30117.10.194	
			 ARGENTO	30117.10.197	
			 WICKER *	30117.10.198	
piano werzalit-topalit ø80 (iceberg)					
	 	 7,1  1 0,025 m ³  40 pz 	 BIANCO	30118.10.190	€ 84,00
			 CATALAN	30118.10.194	
			 ARGENTO	30118.10.197	
			 WICKER *	30118.10.198	
piano werzalit-topalit 60x60 (iceberg)					
	 	 4,9  1 0,015 m ³  40 pz 	 BIANCO	30106.10.190	€ 87,00
			 CATALAN	30106.10.194	
			 ARGENTO	30106.10.197	
			 WICKER *	30106.10.198	
piano werzalit-topalit 70x70 (iceberg)					
	 	 7,7  1 0,020 m ³  40 pz 	 BIANCO	30107.10.190	€ 106,50
			 CATALAN	30107.10.194	
			 ARGENTO	30107.10.197	
			 WICKER *	30107.10.198	
piano werzalit-topalit 80x80 (iceberg)					
	 	 6,7  1 0,026 m ³  40 pz 	 BIANCO	30108.10.190	€ 124,00
			 CATALAN	30108.10.194	
			 ARGENTO	30108.10.197	
			 WICKER *	30108.10.198	

* Piani da utilizzare solo in zone ombreggiate
 Only use table tops in shaded areas

PIANI WERZALIT-TOPALIT CON INSERTI / werzalit-topalit tops with inserts (calice - scudo - scudo double - ibisco - fiore - flute - break)





















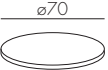









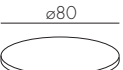









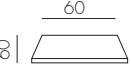







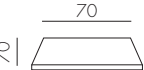

modello model	info info	colore colour	ref. ref.	€ €
piano werzalit-topalit ø60 (con inserti/with inserts)				
	 	 4  1 0,017 m ³	 GRANITO *	30016.10.189
		 	 BIANCO	30016.10.190
			 CATALAN	30016.10.194
			 ARGENTO	30016.10.197
			 WICKER *	30016.10.198
piano werzalit-topalit ø70 (con inserti/with inserts)				
	 	 4,9  1 0,019 m ³	 GRANITO *	30017.10.189
		 	 BIANCO	30017.10.190
			 CATALAN	30017.10.194
			 ARGENTO	30017.10.197
			 WICKER *	30017.10.198
piano werzalit-topalit ø80 (con inserti/with inserts)				
	 	 6,8  1 0,025 m ³	 GRANITO *	30018.10.189
		 	 BIANCO	30018.10.190
			 CATALAN	30018.10.194
			 ARGENTO	30018.10.197
			 WICKER *	30018.10.198
piano werzalit-topalit 60x60 (con inserti/with inserts)				
	 	 4,9  1 0,015 m ³	 GRANITO *	30006.10.189
		 	 BIANCO	30006.10.190
			 CATALAN	30006.10.194
			 ARGENTO	30006.10.197
			 WICKER *	30006.10.198
piano werzalit-topalit 70x70 (con inserti/with inserts)				
	 	 7,2  1 0,020 m ³	 GRANITO *	30007.10.189
		 	 BIANCO	30007.10.190
			 CATALAN	30007.10.194
			 ARGENTO	30007.10.197
			 WICKER *	30007.10.198

* Piani da utilizzare solo in zone ombreggiate
 Only use table tops in shaded areas

modello model	info info	colore colour	ref. ref.	€
piano werzalit-topalit 80x80 (con inserti/with inserts)				
	 	 0,026 m ³ 40 pz 	GRANITO *	30008.10.189
			BIANCO	30008.10.190
			CATALAN	30008.10.194
			ARGENTO	30008.10.197
			WICKER *	30008.10.198
piano werzalit-topalit 110x70 (con inserti/with inserts)				
	 	 0,035 m ³ 40 pz 	BIANCO	30021.10.190
			CATALAN	30021.10.194
			ARGENTO	30021.10.197
piano werzalit-topalit 120x80 (con inserti/with inserts)				
	 	 0,044 m ³ 40 pz 	BIANCO	30020.10.190
			CATALAN	30020.10.194
			ARGENTO	30020.10.197

* Piani da utilizzare solo in zone ombreggiate
 Only use table tops in shaded areas

PIANI WERZALIT-TOPALIT SENZA AGGANCI O INSERTI (PIANI SCIOLTI) / werzalit-topalit top without hooks or inserts (loose tops)

modello model	info info	colore colour	ref. ref.	€ €
piano werzalit-topalit ø60				
	  4,3  1 0,011 m ³  60 pz 	 BIANCO	1801430.00.190	€ 50,00
		 CATALAN	1801430.00.194	
		 ARGENTO	1801430.00.197	
		 WICKER *	1801430.00.198	
piano werzalit-topalit ø70				
	  5,1  1 0,012 m ³  60 pz 	 BIANCO	1801630.00.190	€ 63,00
		 CATALAN	1801630.00.194	
		 ARGENTO	1801630.00.197	
		 WICKER *	1801630.00.198	
piano werzalit-topalit ø80				
	  6,9  1 0,016 m ³  60 pz 	 BIANCO	1801930.00.190	€ 65,00
		 CATALAN	1801930.00.194	
		 ARGENTO	1801930.00.197	
		 WICKER *	1801930.00.198	
piano werzalit-topalit 60x60				
	  5  1 0,011 m ³  60 pz 	 BIANCO	1801530.00.190	€ 72,00
		 CATALAN	1801530.00.194	
		 ARGENTO	1801530.00.197	
		 WICKER *	1801530.00.198	
piano werzalit-topalit 70x70				
	  6,7  1 0,015 m ³  50 pz 	 BIANCO	1801730.00.190	€ 90,00
		 CATALAN	1801730.00.194	
		 ARGENTO	1801730.00.197	
		 WICKER *	1801730.00.198	

* Piani da utilizzare solo in zone ombreggiate
 Only use table tops in shaded areas

modello model	info info	colore colour	ref. ref.	€ €
piano werzalit-topalit 80x80				
	W-T 9,5 1 0,019 m ³ 50 pz 	BIANCO	1801830.00.190	€ 106,50
		CATALAN	1801830.00.194	
		ARGENTO	1801830.00.197	
		WICKER *	1801830.00.198	
piano werzalit-topalit 110x70				
	W-T 10,8 1 0,023 m ³ 50 pz 	BIANCO	1802130.00.190	€ 121,50
		CATALAN	1802130.00.194	
		ARGENTO	1802130.00.197	
piano werzalit-topalit 120x80				
	W-T 15 1 0,029 m ³ 50 pz 	BIANCO	1802030.00.190	€ 154,00
		CATALAN	1802030.00.194	
		ARGENTO	1802030.00.197	

* Piani da utilizzare solo in zone ombreggiate
Only use table tops in shaded areas

CUSCINI E
ACCESSORI

cushions and
accessories

modello
model

info
info

colore
colour

ref.
ref.

€
€

cuscinio net relax

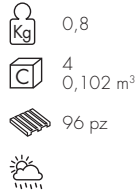
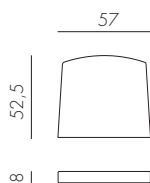

	ROSA VENEZIA	36327.00.038
	TERRA D'OMBRA	36327.00.039
	OCRA GIALLA	36327.00.040
	ROSSO SINOPIA	36327.00.041
	TURCHESE	36327.00.042
	BLU LAPIS	36327.00.043
	GRIGIO	36327.00.163
	GRIGIO Sunbrella®	36327.00.136

€ 39,00

€ 78,00

cuscinio net

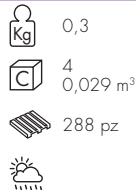
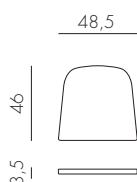

	GRIGIO	36326.00.163
	GRIGIO Sunbrella®	36326.00.136

€ 20,00

€ 49,00

cuscinio seduta aria

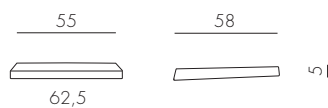

	LIME	36330.00.061
	CHERRY	36330.00.065
	MELANZANA	36330.00.068
	BIANCO	36330.00.155
	CAFFÈ	36330.00.165
	ARANCIO	36330.00.166
	GRIGIO	36330.00.163
	GRIGIO Sunbrella®	36330.00.136

€ 41,00

€ 79,50

cuscinio arredo aria

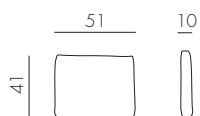

	LIME	36330.01.061
	CHERRY	36330.01.065
	MELANZANA	36330.01.068
	BIANCO	36330.01.155
	CAFFÈ	36330.01.165
	ARANCIO	36330.01.166
	GRIGIO	36330.01.163
	GRIGIO Sunbrella®	36330.01.136

€ 27,00

€ 46,00

modello model	info info	colore colour	ref. ref.	€ €	
cusciino acquamarina					
			BIANCO	36314.00.155	€ 75,00
			GRIGIO	36314.00.163	
			CAFFÈ	36314.00.165	
			GRIGIO Sunbrella®	36314.00.136	€ 125,00
cusciino darsena					
			BIANCO	36316.00.155	€ 68,00
			GRIGIO	36316.00.163	
			CAFFÈ	36316.00.165	
			GRIGIO Sunbrella®	36316.00.136	€ 119,00
cusciino eden					
			ECRÙ	36414.01.160	€ 115,50
			BLU	36414.00.076	
distanziali bistrot					
			ANTRACITE	202.430.402	€ 2,80
detergente clean resin 0,5 lt					
				39101.00.000	€ 5,70
detergente clean resin special 5 lt					
				39102.00.000	€ 135,00

MATERIALI

materials

POLIPROPILENE/polypropylene

Polipropilene trattato anti-UV e colorato in massa. Riciclabile al 100%
Polypropylene with UV additives and is uniformly colored. 100% Recyclable resin.

POLIPROPILENE FIBERGLASS/polypropylene fiberglass

Polipropilene fiberglass trattato anti-UV e colorato in massa. Resina riciclabile al 100%.
Uniformly colored fiberglass polypropylene resins with uv additives. 100% Recyclable resin.

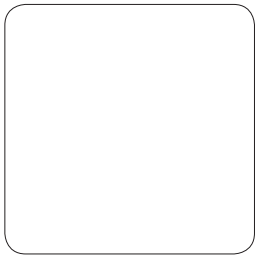

BIANCO .00



ANTRACITE .02

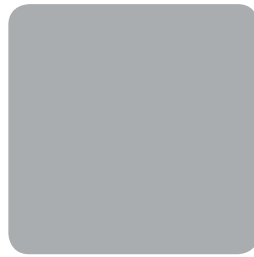

GRIGIO .03



SALICE .04

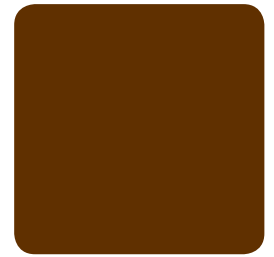

CAFFE' .05



ROSSO .07

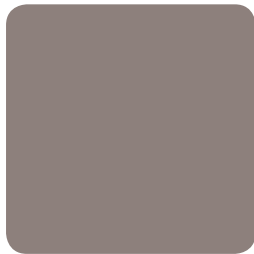

TORTORA .10



LIME .12



ARANCIO .26



BURRO .28



PAGLIA .29



AVANA .33



CELESTE .39



SENAPE .56

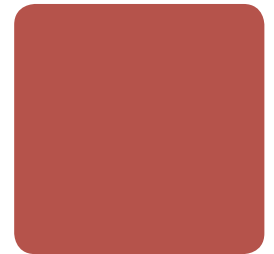

CORALLO .75



DURELTOP

DurelTOP è un sistema innovativo di produzione di piani per tavoli studiati per raggiungere i più elevati livelli di praticità, resistenza, robustezza ed eleganza. I piani DurelTOP sono ad alto spessore, formati da un doppio strato tamburato perfettamente chiuso. Prodotti in polipropilene di prima qualità, sono inalterabili all'acqua, resistenti al sole e facili da pulire. DurelTOP è il risultato di una lunga ricerca tecnologica e dell'esperienza decennale nella lavorazione delle materie plastiche della Nardi, da sempre all'avanguardia nell'ambiente contract e giardino.

The DurelTOP is an innovative new system in the production of tabletops developed to reach the highest levels of practicality, resistance, and elegance. The DurelTOP tabletops have a greater thickness, formed by a double layer enclosure perfectly closed. Produced in first quality polypropylene, they are resistant to water, resistant to sunlight, and are easy to clean. DurelTOP is a result of a decade's long research and development in plastics by Nardi, always a leader in the contract and garden sectors.

ALLUMINIO/aluminium

ALLUMINIO ANODIZZATO/aluminium anodized

L'anodizzazione è un processo elettrolitico che aumenta l'ossidazione delle superfici prevenendo la corrosione con uno strato protettivo.

Anodizing is an electrolytic procedure that increases oxidation of the surfaces, preventing corrosion with a protective layer.

ALLUMINIO VERNICIATO/coated aluminium

La verniciatura è a polvere di poliestere.

The painting is with polyester powder.

ALLUMINIO VERNICIATO TRATTAMENTO SPECIALE/ coated aluminium special treatment

Alluminio con trattamento speciale per ambienti ad alto tasso salino.

Aluminium special treatment for high salinity environments.



anodizzato .50



verniciato antracite .52



verniciato bianco .53



verniciato argento .54



verniciato caffè' .57



verniciato burro .58



verniciato tortora .59

LAMINATO HPL/laminate HPL

Laminato decorativo ad alta pressione, compatto, omogeneo, non poroso, ad alta densità.

Decorative high pressure laminate, solid, homogeneous, nonporous and with a high density.



GRIGIO .300



BIANCO .301



CAFFÈ .302

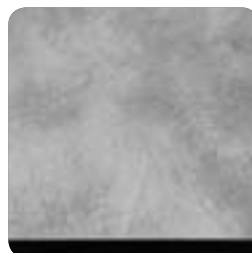

ANTRACITE .303



CEMENTO .305



TORTORA .310



LEGNO .311

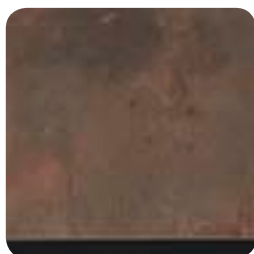

CORTEN .312

WERZALIT-TOPALIT/werzalit-topalit

Piano speciale protetto da laminato melamminico decorato, di facile pulizia, resistente alle macchie, al calore, alle intemperie.

Werzalit-topalit tops are protected by a special printed foil that is weather proof, easy to clean and resistant to marks and heat.

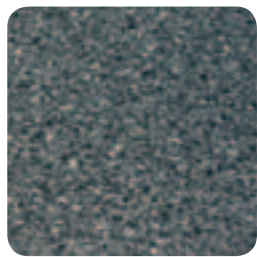

GRANITO .189



BIANCO .190



CATALAN .194



ARGENTO .197

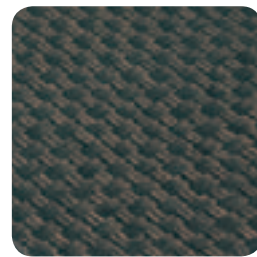

WICKER .198

VETRO/glass

Vetro float temperato serigrafato e vetrificato a 700°C.

Tempered Float glass, screen-printed and vitrified at 700° C.



BIANCO .00



ANTRACITE .02



CAFFÈ .05

TESSUTO ACRILICO CUSCINO EDEN /acrylic fabric eden cushion

Fibra Acrilica 100%. Solidità alla luce 7/8. Sfoderabile/zip, lavabile a 30°. imbottitura: poliuretano espanso. Densità 18 kg/m³. Trattamento con resina poliuretana/acrilica, idrorepellente.

100% acrylic fiber. Light fastness 7/8. Removeable/zip, wash at 30°. Padding: polyurethane foam. Density 18 kg/m³. Finish resin poliuretano/acrilica, water-repellent



blu .076



ecru .160

TESSUTO ACRILICO/acrylic fabric



Fibra Acrilica 100% tinta in massa. Solidità alla luce 7/8. Sfoderabile/zip, lavabile a 30°. CUSCINO SEDUTA = imbottitura: poliuretano espanso. Densità 25 kg/m³. CUSCINO ARREDO = imbottitura: poliuretano espanso. Densità 25 kg/m³ rivestito da fibra 100% poliestere. Trattamento antimacchia, antimuffa.

100% acrylic fiber mass dyed. Light fastness 7/8. Removeable/zip, washable at 30°. CUSCINO SEDUTA = padding: polyurethane foam. Density 25 kg/m³. CUSCINO ARREDO = padding: polyurethane foam. Density 25 kg/m³ with polyester fiber 100%. Stain-proof, mould-proof.



lime .061
240 gr/m²



cherry .065
240 gr/m²



melanzana .068
190 gr/m²



bianco .155
190 gr/m²

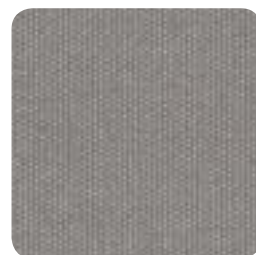

grigio .163
240 gr/m²



caffè .165
190 gr/m²



arancio .166
190 gr/m²

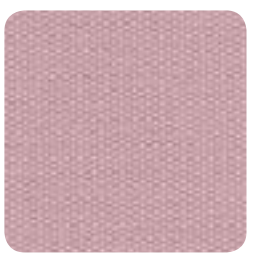

rosa venezia .038
190 gr/m²



terra d'ombra .039
190 gr/m²



ocra gialla .040
190 gr/m²



rosso sinopia .041
190 gr/m²



turchese .042
190 gr/m²



blu lapis .043
190 gr/m²

TESSUTO ACRILICO Sunbrella® NATTÈ/ Sunbrella® NATTÈ acrylic fabric

100% fibra acrilica SUNBRELLA® tinta in massa, con trattamento CLEANGARD® idrorepellente e anti-macchia. Solidità alla luce 8/8. Sfoderabile con ZIP, lavabile a 40°.

100% acrylic SUNBRELLA® fibre, batch dyed, with CLEANGARD® water-repellent and stain-resistant treatment. 8/8 light fastness. Removeable cover with ZIP fastening, washable at 40°.

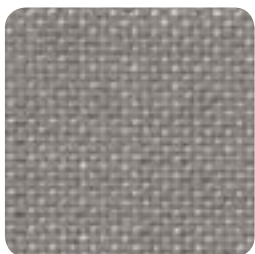

grigio Sunbrella® .136
280 gr/m²

TESSUTO SINTETICO/synthetic fabric

Tessuto in filo di poliestere rivestito in pvc.
Fabric is made of a polyester fiber, with a pvc coating.

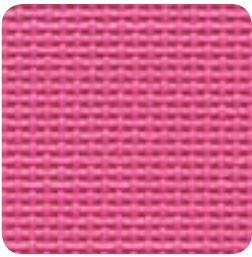

rosa
tela 1x1 .056

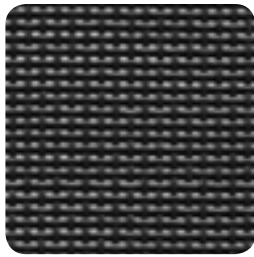

antracite
tela 1x1 .057

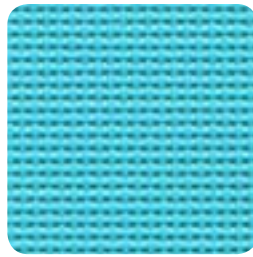

celeste
tela 1x1 .075



trama beige .078

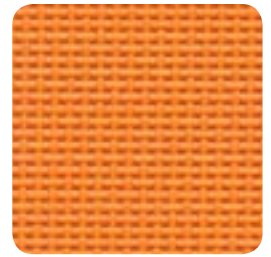

mandarino
tela 1x1 .083

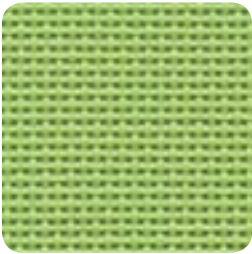

prato
tela 1x1 .084

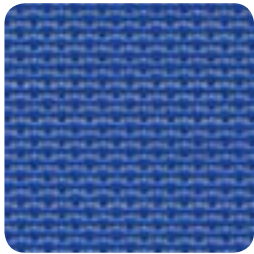

blu
tela 1x1 .102

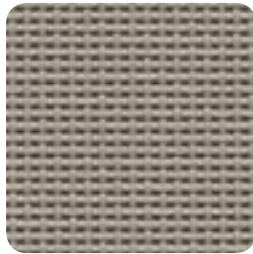

tortora
tela 1x1 .104

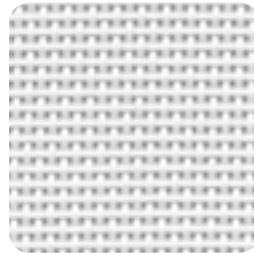

bianco
tela 1x1 .107



bianco
tela 2x2 .108

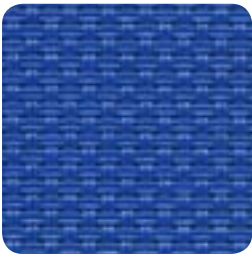

blu
tela 2x2 .112



beige
tela 2x2 .115

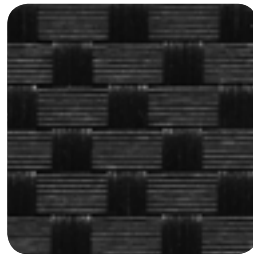

trama antracite .116



trama caffè .117



trama bianco .121



tortora
tela 2x2 .124

condizioni generali di vendita
general terms of sale

NARDI SPA – CONDIZIONI GENERALI DI VENDITA

Gli ordini vengono accettati esclusivamente alle seguenti condizioni

1. **Condizioni di vendita e prezzi**
 - 1.1 Le presenti condizioni di vendita e listino prezzi sostituiscono i precedenti.
 - 1.2 I prezzi indicati sono da intendersi "prezzi suggeriti" per l'utente finale Iva esclusa.
 - 1.3 La Nardi Spa si riserva il diritto di modificare il listino e di offrire eventuali offerte in qualsiasi momento, in caso di fluttuazioni (del costo della materia prima, del costo del lavoro e/o di altri fattori) che influenzino i prezzi oltre la norma, e ciò senza necessità di preavviso.
 2. **Cataloghi**
 - 2.1 Sono da considerarsi articoli standard solamente quelli indicati sul catalogo vigente al momento dell'ordine. I dati tecnici e le fotografie riportate sui cataloghi sono da considerarsi meramente indicativi. La Nardi Spa si riserva il diritto di apportare modifiche e varianti sui prodotti ed eliminare articoli dalla produzione, il tutto senza alcun preavviso e ciò anche durante la vigenza del catalogo.
 - 2.2 Tutte le immagini realizzate dalla Nardi sono protette da copyright e non possono essere utilizzate, riprodotte, modificate, riprodotte sul web, senza il consenso scritto della Nardi. Il cliente che abbia ottenuto l'autorizzazione deve inoltre mantenere i nomi dei prodotti come indicato sul catalogo Nardi e a pubblicarli con il marchio Nardi.
 3. **Ordini**
 - 3.1 L'ordine inoltrato dal cliente si intende accettato dalla Nardi Spa solo se confermato dalla stessa in forma scritta.
 - 3.2 Per ordini di articoli particolari, al di fuori del nostro standard, la Nardi Spa si riserva il diritto di richiedere un acconto alla conferma d'ordine e di precisare altre condizioni di vendita e pagamento.
 - 3.3 La Nardi Spa è sollevata da ogni responsabilità per mancata e/o errata comunicazione di dati da parte del cliente.
 - 3.4 Le date di consegna della merce si intendono sempre come indicative e non tassative (ad ogni modo la Nardi Spa è espressamente sollevata da ogni responsabilità e/o danno riguardante ritardi di consegna dovuti a cause di forza maggiore o caso fortuito).
 4. **Canale on-line**
 - 4.1 La vendita dei prodotti sul canale on-line è consentita solo contestualmente alla presenza del prodotto presso il negozio fisico del cliente, salvo diversi accordi in forma scritta con l'azienda Nardi.
 - 4.2 L'utilizzo da parte del cliente di piattaforme di vendita on-line non proprie deve essere preventivamente autorizzato dalla Nardi.
 5. **Imballi**
 - 5.1 I nostri imballi sono forniti gratuitamente e sono adatti a trasporti standard.
 - 5.2 Eventuali richieste di imballi particolari sono soggette a maggiorazione di prezzo da concordare.
 6. **Trasporto**
 - 6.1 La merce viaggia a rischio e pericolo dell'acquirente.
 - 6.2 Eventuali discordanze, ammanchi o danni riscontrati allo scarico, devono essere rilevati con specifica riserva sul ddt o cmr e tempestivamente comunicati in forma scritta alla Nardi Spa, e comunque entro e non oltre i 7 giorni lavorativi. Il compratore è tenuto a controllare con attenzione la merce ricevuta, e a comunicare eventuali danni, non rilevabili allo scarico, entro 7 gg dalla data di avvenuta consegna.
 7. **Resi di merce**
 - 7.1 I resi della merce non si possono accettare senza previa autorizzazione scritta della Nardi Spa, ed in qualsiasi caso i costi per il reso della merce sono a carico del compratore.
 8. **Ritardo nei pagamenti**
 - 8.1 Nel caso di ritardo nei pagamenti verranno applicati gli interessi di mora cui al D.L. 231/02 (con successive norme di attuazione).
 9. **Riserva di proprietà**
 - 9.1 La merce consegnata rimane di proprietà della Nardi Spa fino al suo integrale pagamento ed in caso di emissione di assegni o di effetti commerciali fino al buon esito degli stessi. La Nardi Spa si riserva a suo insindacabile giudizio la facoltà di ritirare la merce nel caso in cui non venissero rispettati i pagamenti previsti. Durante la vigenza della riserva di proprietà tutti i rischi sono trasferiti al compratore fin dal momento dell'uscita delle merci dal magazzino del venditore; spetta quindi al compratore assicurare la merce contro i rischi e danni.
 10. **Termini di garanzia**
 - 10.1 I prodotti sono garantiti a termini di legge contro tutti i difetti di fabbricazione in condizioni normali di utilizzo.
 - 10.2 Eventuali difetti della merce devono essere comunicati per iscritto riportando i numeri di controllo qualità riportati sull'articolo e imballo, e possibilmente comprovati da foto del prodotto difettoso.
 11. **Foro competente**
 - 11.1 Foro competente per tutte le controversie attinenti ai prodotti della Nardi Spa, ogni ordine e contratto: Autorità Giudiziaria Ordinaria avente giurisdizione su Chiampo (VI) Italia.
- Si approvano espressamente le clausole 8.1-9.1-11.1

1° Ottobre 2016

NARDI SPA – GENERAL TERMS OF SALE

Orders are accepted only on the following terms

1. Terms of sale and prices

- 1.1 These terms of sale and price-list replace the previous ones.
- 1.2 The prices indicated are “suggested prices” intended for final consumer, excluding taxes.
- 1.3 Nardi Spa reserves the right to review the price-list, and eventual offers, at any time, in case of fluctuations (of the raw materials cost, labour costs and/or other factors) which influence the prices beyond the norm, and that without giving notice.

2. Catalogues

- 2.1 Standard items are only those on the operative catalogue at the moment of the order. Technical data and pictures in the catalogues have to be considered as indicative. Nardi Spa reserves the right to bring modifications and variances on the products and eliminate articles from the production, all without some notice even during the validity of the catalogue.
- 2.2 All images created by Nardi are protected by copyright© and cannot be used, reproduced, modified or published on-line without Nardi’s written consent. Clients who obtain an authorization must also maintain the names of the products as indicated in the Nardi catalogue and publish them with the Nardi brand.

3. Orders

- 3.1 Orders forwarded by the customer are considered as accepted only after written confirmation by Nardi Spa.
- 3.2 About orders of particular items, out of our standard, Nardi Spa reserves the right to ask for a partial payment on the confirmation of order, and specify other terms of sale and payment.
- 3.3 Nardi Spa is released from every responsibility for none or wrong communication of data from the customer.
- 3.4 Delivery dates of the goods are always to be considered as approximate and not binding. (In any case Nardi spa is expressly released from any responsibility and/or damage regarding delays of delivery due to force majeure reasons or fortuitous event).

4. On-line channel

- 4.1 The sale of products on the on-line channel is only permissible if the product is actually available in the client’s shop, unless otherwise agreed in writing with Nardi.
- 4.2 Use on behalf of clients of on-line sales platforms which do not belong to them must be authorised by Nardi in advance.

5. Packing

- 5.1 Our packing is supplied free of charge and is suitable for standard shipments.
- 5.2 Eventual requests of special packing are subjected to a price

increase to be agreed.

6. Transport

- 6.1 The goods travel at buyer’s risk.
- 6.2 Eventual discrepancies, lack of goods or damages, found while unloading, must be duly noted on the delivery note or CMR and timely reported in writing to Nardi Spa, not later than 7 working days. The buyer is obliged to check carefully the received goods and inform Nardi Spa about eventual damages, not found while unloading, within 7 days from the date of receipt of the goods.

7. Returns of goods

- 7.1 Returns of goods cannot be accepted without previous written authorization of Nardi Spa, and in any case, the expenses for returning of the goods are charged to the purchaser.

8. Delay in Payments

- 8.1 In case of delay in payments we will apply interest in accordance with D.L.231/02 (and subsequent rules of execution).

9. Retention of ownership

- 9.1 Nardi Spa retains ownership of all merchandise delivered till its complete payment or, in case of cheques and drafts, till their encashment. Nardi Spa reserves the right to take back the goods if due payments are not respected. During the term of the retention of ownership, all risks are charged to the purchaser from the time the goods leave the seller’s warehouse. It is up to the purchaser to insure the goods against risks and damages.

10. Guarantee

- 10.1 Products are guaranteed, according to the law, against all manufacturing defects when used in ordinary conditions.
- 10.2 Eventual defects of the goods must be reported in writing, stating the quality control number that appear on the item and on the packaging, possibly proved by pictures of the defective product.

11. Place of Jurisdiction

- 11.1 Place of jurisdiction for all disputes regarding Nardi products, every order and contract is: Ordinary Judicial Authority having jurisdiction over Chiampo (VI) Italy.

Clauses 8.1-9.1-11.1 are expressly approved.

1st October 2016

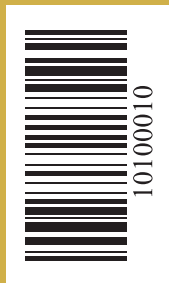

2017 - EXTRA



YOUR OUTDOOR LIVING

NARDI s.p.a.
Chiampo (VI) Italy
tel. +39 0444 422100
info@nardigarden.it
www.nardigarden.com

P.IVA - REG.IMPRESSE VI ISO IT 02114700244
R.E.A. 207085 - Cap.Soc. 6.000.000 e int.vers.